

# INSTRUCTION MANUAL

## POLAR ENERGY™

---

Version 2.00

14/12/2017



[blank intentionally]

---

## VERSION HISTORY

---

Version #	Implemented By	Revision Date	Comments
1.00	Mikko Kumaleipe	01/07/2017	Version 5.00 of the document
1.10	Mikko Kumaleipe	16/09/2017	400Hz capability added
2.00	Mikko Kumaleipe	14/12/2017	Protocol IEEE802.11 added

Congratulations for choosing ***Polar Energy***, a product stemming from Elcontrol 50-year experience in the control of energy consumption.

The high technology content, the careful attention to the choice of materials, the full compliance to the most recent industrial standards make this tool the 'Polar Star' for effectively and simply finding your way to energy analysis.

Further, Polar Star has been fully developed and tested in Italy. It is therefore manufactured with those high quality standards for all European products, in compliance with the environment, safety and ethics.



# TABLE OF CONTENTS

<b>1 INTRODUCTION TO POLAR ENERGY™</b> .....	<b>9</b>
1.1 Audience .....	9
1.2 Presentation .....	9
1.3 Polar Energy versions .....	11
1.4 Polar Energy options .....	11
1.5 Safety and warranty .....	11
1.6 operator's safety .....	11
1.7 EC, RoHS & WEEE declaration of conformity .....	13
1.9 reference standards .....	14
1.10 warranty conditions .....	15
1.10.1 Warranty disclaimers .....	15
1.10.2 Defect report .....	15
1.10.3 Limitation of liability .....	15
1.10.4 Final provisions .....	15
<b>2 POLAR ENERGY™ INSTALLATION</b> .....	<b>17</b>
2.1 Option Modules .....	18
2.2 Power Supply and electrical connections .....	18
2.3 power supply .....	19
2.4 connection of voltage and amperometric inputs .....	19
2.4.1 3PH+N: unbalanced three-phase network with neutral (4 leads / 3+1 CT) .....	19
2.4.2 3PH+N-BL: Balanced three-phase network with neutral (4 leads / 1 CT) .....	20
2.4.3 3PH: Unbalanced three-phase network without neutral (3 leads / 3 CTs) .....	20
2.4.4 3PH: Unbalanced three-phase network without neutral (3 leads / 2 CTs) .....	21
2.4.5 3PH-BL: Balanced three-phase network without neutral (3 leads / 1 CT) .....	21
2.4.6 2PH: Two-phase network (3 leads / 2 CTs) .....	22
2.4.7 1PH: Single-phase network (2 leads / 1 CT) .....	22
2.4.8 VT connection: Example of connection via Voltage Transformer .....	23
<b>3 START-UP</b> .....	<b>25</b>
3.1 user interface .....	25
3.1.1 Setup and measurements pages .....	25
3.1.2 Keypad .....	26

3.2 Programming and set-up.....	28
3.2.1 Editing and setting values.....	28
3.2.2 Setup menu flowchart.....	28
3.2.3 Connection set-up.....	29
3.2.4 Counters Reset.....	30
3.2.5 Language setup.....	31
3.2.6 LCD Setup.....	31
3.2.7 Alarm Setup and Reset.....	32
<b>4 INSTRUMENT USE AND CONSULTATION .....</b>	<b>35</b>
4.1 Connection check.....	35
4.2 Measurement menu scrolling.....	35
4.3 Three-phase or Two-phase Connection Menu .....	36
4.3.1 Voltage Menu.....	36
4.3.2 Current menu.....	37
4.3.3 Power Menu.....	37
4.3.4 Counters Menu .....	38
4.3.5 THD Menu.....	38
4.3.6 Waveform Menu.....	38
4.4 Single phase connection menu.....	39
4.4.1 V I PF F Menu.....	39
4.4.2 P Q S PF Menu.....	40
4.4.3 Counters Menu .....	41
4.4.4 THD Menu.....	41
4.4.5 Waveform Menu.....	41
<b>5 MAINTENANCE .....</b>	<b>41</b>
5.1 Accuracy Checking .....	41
5.2 Repair.....	42
5.3 Troubleshooting .....	42
5.3.1 The instrument does not turn on.....	42
5.3.2 The instrument does not measure correctly. ....	42
5.3.3 The display is unclear. ....	42
5.3.4 After a few seconds, the display loses its brightness. ....	42
5.3.5 The display is always on, even if the setting chosen should prevent this from happening.	42
5.3.6 Some pages or menus are not displayed. ....	42
5.3.7 The instrument lost date and time. ....	42
5.3.8 Countless alarms have been signalled. ....	42
<b>6 POLARLINK SOFTWARE .....</b>	<b>43</b>

---

<b>7 TECHNICAL SPECIFICATIONS</b> .....	<b>45</b>
<b>8 OPTION MODULES</b> .....	<b>49</b>
8.1 RS485 Option Modules .....	49
8.1.1 RS485 Option connections .....	49
8.1.2 RS485 Option setup .....	49
8.1.3 Communication test .....	50
8.1.4 Date/Time configuration.....	50
8.2 ALM option .....	51
8.2.1 ALM Option Connection.....	51
8.2.2 ALM Option Setup .....	52
8.2.3 Alarm 1 or 2 Setup .....	52
8.2.4 Pulse output 1 or 2 Setup .....	53
8.3 Digital Inputs Option .....	53
8.3.1 Digital Inputs Option Connections .....	53
8.3.2 Digital inputs Setup .....	54





# 1 INTRODUCTION TO POLAR ENERGY™

## 1.1 AUDIENCE

The audience for this document includes first time users as well experienced Elcontrol Energy Net Srl panel analyzers users.

Basic knowledge of electrical safety, technology and measures is a mandatory requirement.

## 1.2 PRESENTATION

Polar Energy™ is a state-of-the-art device equipped with new functions for monitoring energy consumption and for advanced energy and quality analysis. This device is able to measure, display, process and transmit all the parameters of a plant.

With respect to standard energy analysers, its main features are as follows:

- new standard format enclosure (DIN 96x96 mm) which really conforms to IEC 61554, with a modern and sophisticated design:
  - reduced depth and only 4 cm overall dimensions inside the control board
  - Front panel IP65 protection rating (total resistance to dust and water jets coming from all directions)
  - Plug & Play optional devices can be easily inserted at the back of the device (RS485 power supply digital input and output alarms, 12-24 Vdc and 48-60Vdc, Wireless transmission, etc.)
- for use with power supply and current and voltage inputs of flanged connectors (completely removable but with retaining screws) providing quick installation and total electrical safety thanks to the perfect tightening between male and female connectors
- switching power supply, 90 up to 230VAC 50-60Hz and 90 up to 300V (+ options 12-24V and 48-60V )
- backlit graphic LCD, high efficiency 128x128 pixels for a high quality display (multilingual menu, waveforms, histograms, customised pages, charts, schemes, images, etc.)
- 3 voltage measuring channels up to 600V Cat III, with a  $\pm 0.25\% + 0.05FS$  accuracy
- 4 independent current inputs (3 + 1 which may be used for measuring, for example, the neutral current), with a  $\pm 0.25\% + 0.05FS$  accuracy
- 4 internal CTs for improved electrical insulation (only TOP version)
- new calculation engine based on a new 16-bit microprocessor which provides measuring of all standard measures (V I P Q A F PF THD% etc.) with effective value (TRMS) and:
  - measuring of minimum, average maximum and instant values on 4 dials (absorbed and generated type)
  - password-protectable energy counters (kWh kVA kVAr) for both absorbed and produced energy
  - Energy quality analysis through measuring of:
    - current and voltage harmonics (all 7 input channels) up to the 31st order;
    - power and micro-power blackouts (TOP version only)
    - Dips (voltage losses) in TOP version
    - Swells (overvoltages) in TOP version
    - EN50160 test (reference standard for energy quality) in TOP version

- Event data logger (5 alarms, 5 dips, 5 swells, 5 interruption) in TOP version
- graphic display of trends (time progress) of 5 selectable measures (TOP version)
- energy measurement in 4 time periods (tariffs) (tariffs can be freely set) (TOP version)
- For both three-phase and each single phase
- 6 electrical systems which can be analysed: (i) single-phase type; (ii) two-phase type; (iii) three-phase with 3 leads (unbalanced type); (iv) three-phase with 4 leads (unbalanced type); (v) three-phase with 3 leads (balanced type); (vi) three-phase with 4 leads (balanced type)
- mean voltage connection is possible
- Users can customise the screens according to their preferences
- Multilingual menu (English, Italian, German, Spanish and French)
- Automatic test connection for checking the electrical connections
- Automatic option recognition
- Check of RS485 communication (if any)
- Dedicated PC software for detecting and remotely configuring the instrument\*

### 1.3 POLAR ENERGY VERSIONS

Code	Model	Description
4BAAA	Polar Energy	Polar Energy base instrument

### 1.4 POLAR ENERGY OPTIONS

Code	Model	Description
4A485	Option	RS485 expansion option
4AALM	Option	2 Alarm option
4ADIN	Option	Digital input option
4AVDC	Option	12-24 VDC
41VDC	Option	48-60 VDC

### 1.5 SAFETY AND WARRANTY

Polar Energy™ has been designed and tested in compliance with the most recent industrial Directives and is supplied by the manufacturer in perfect technical safety conditions. In order to maintain these conditions and ensure safe operation, the user should follow the instructions and the markings in these user instructions.

**CAUTION! Please read these instruction carefully before using the devices.**

### 1.6 OPERATOR'S SAFETY

- The instrument described herein must only be used by trained personnel.
- Maintenance and installation operations should be carried out only by qualified and authorised personnel in order to avoid any risk of electrocution, shock or burns.
- For proper and safe use of the device and for its installation and maintenance, the people in charge of these operations should observe standard safety procedures. Failure to do so will relieve the manufacturer of all responsibilities.
- Before using, servicing or repairing, disconnect the instrument and the housing board from any voltage source.
- Before performing the electrical connections or any interventions on the device, short-circuit the CT secondary winding and switch off the power supply.
- Before the start-up, check the following:
  - network voltage should fall within the range indicated in the specification;
  - the maximum voltage at the voltage inputs should be 700VAC phase/phase or 400VAC phase/neutral
- After checking that safe operation is no longer possible, the instrument should be taken out of service and ensured against accidental use. Safe operation is no longer possible in the following cases:
  - when the instrument exhibits clearly visible damages;
  - when the instrument is not working anymore;
  - after long storage under negative conditions;

- after serious damages undergone during transport.

The symbol shown here on the right - when found on the product or elsewhere - means that the user manual must be consulted. The instrument described herein must only be used by trained personnel.



## 1.7 EC, ROHS & WEEE DECLARATION OF CONFORMITY

Manufacturer:	ELCONTROL ENERGY NET S.r.l. Via Vizzano 44 40044 Sasso Marconi (BO) - Italy
Product:	<b>POLAR ENERGY™</b>
Directives complied with:	93/68/EEC (Low Voltage Electrical Equipment); 89/336/EEC and 2004/108/EC (EMC - Electromagnetic Compatibility); 2006/95/EC - 72/23/EEC (LVD - Low Voltage Directive); 2002/95/EC (RoHS); 2002/96/EC and 2003/108/EC (WEEE).
Year of mark affixing:	2009
Certificate:	12CDC27 by Lem S.r.l. Notified Body
Reference standards for EC compliance:	EN 61010-1 EN 61010-1 EN 61326 EN 61326/A1 EN 61326/A2 EN 61326/A3
Reference standard for mechanical dimensions:	IEC 61554 (ex DIN 43700)

## 1.9 REFERENCE STANDARDS

Standard	Title	Description	Int. Link
EN 61010-1	Safety requirements for electrical equipment for measurement, control, and laboratory use.	General safety requirements for electrical equipment intended for professional, industrial process, and educational use. Electrical test and measurement, control, and laboratory equipment.	Identical to IEC 61010-1:2001-02 EN 61010-1:2001-03
EN 61326	Electrical equipment for measurement, control and laboratory use. EMC requirements.	This Standard specifies the minimum requirements for immunity and emissions regarding electromagnetic compatibility (EMC) for electrical equipment, operating from a supply or battery of less than 1000 VAC or 1500 VDC, intended for professional, industrial-process, industrial-manufacturing and educational use, including equipment and computing devices for measurement and test; control; laboratory use; accessories intended for use with the above equipment.	Identical to IEC 61326-1: 1997-03 EN 61326-1:1997-04 EN 61326-1 Ec:1998-01
EN 61326/A1	Electrical equipment for measurement, control and laboratory use. EMC requirements.	This amendment modifies the requirements for the immunity tests laid down in Standard IEC EN 61326 for the three specific applications specified below: Use in industrial environment; use in laboratories or test and measurement areas with electromagnetically-controlled environments; portable test and measurement equipment operating from a battery or from the circuit being measured.	Identical to IEC 61326-1/A1: 1998-05 EN 1326/A1: 1998-06 EN 61326-1 Ec:1998-09
EN 61326/A2	Electrical equipment for measurement, control and laboratory use. EMC requirements.	This amendment adds an annex to the basic Standard introducing more detailed specifications regarding test configurations, operating conditions, and performance criteria for certain equipment intended for applications where no special EMC requirements are provided. Some examples of such equipment are: oscilloscopes, logic analysers, spectrum analysers, digital multimeters, etc.	Identical to IEC 61326-1/A2: 2000-08 EN 61326/A2: 2001-05
EN 61326/A3	Electrical equipment for measurement, control and laboratory use. EMC requirements	This amendment to IEC EN 61326 (IEC 65-50) adds regulatory Annexes E & F to the basic Standard, regarding test configurations, operating conditions, and performance criteria for portable test, measurement and monitoring equipment which are used in low voltage distribution systems.	Identical to: IEC 61326:2002-02 (Annex E & F); IEC 61326/Ec1:2002-07 EN 61326/A3:2003-12

## 1.10 WARRANTY CONDITIONS

### 1.10.1 Warranty disclaimers

Elcontrol guarantees that each POLAR ENERGY™ is free of defects, complies with technical specifications, and is suitable for the purposes declared by Elcontrol for a **period of twelve (12) months from the documented purchase date** or, in the absence of said date, the date of calibration.

The warranty covers faulty hardware parts, but not software, consumables, labour and transport costs.

Repairs under warranty shall only be performed if Elcontrol actually finds manufacturing defects or poor material quality.

The warranty shall no longer be valid if the defect is due to: incorrect electrical power supply, swells, improper connections, tampering, repairs or modifications carried out without the prior consent of the manufacturer, accidents or use other than that described herein. Damage resulting from disuse or any harm caused to third parties shall not be covered.

The warranty shall no longer be valid if the Quality check stick will be removed or damaged.

Faulty products must be returned to the importer/distributor of your country or to Elcontrol (**DELIVERED DUTY PAID**), subject to prior consent of Elcontrol.

A request for repair under warranty shall be accompanied by proof-of-purchase, stating the date on which the product was purchased. The warranty shall not be valid for products which have not been paid by the purchaser by the agreed deadline, as well as if the faulty product is returned from a country other than that where the product was sold, unless otherwise agreed.

### 1.10.2 Defect report

Any defect reports regarding delivered products - whether apparent or latent - shall be submitted to Elcontrol in writing.

The purchaser can in no way return the products without the prior consent of Elcontrol or following the decision of the judicial authorities.

Products must be returned within ten (10) days of the consent of Elcontrol or the judicial authorities.

In the event of a report - regardless of the object and reason therefore - the purchaser shall pay the full amount indicated on the invoice. If the delivered products have been modified, altered or used by the purchaser, no report shall be accepted or deemed valid.

Discrepancies which are deemed customary in trade, as well as discrepancies which cannot be technically avoided, especially those concerning quality, colours, manufacturing processes, drawings and similar aspects, cannot be the object of a claim.

Elcontrol reserves the right to make any changes to its products without altering their quality or performance. Such changes cannot be the object of a claim.

Whenever Elcontrol receives a claim regarding the condition of a product, quality defects or non-compliance with technical specifications, Elcontrol shall have the right - in its sole discretion - to replace the products without any charge, repair the products or issue a credit note.

Any kind of damage is excluded.

In case of interventions under the warranty period, all shipping costs for repairing and/or replacing the faulty products shall be borne by the purchaser.

### 1.10.3 Limitation of liability

Except for the warranty, Elcontrol shall in no way be liable for any direct or indirect damage incurred by the purchaser, such as – but not limited to – material damage, damage for loss in profit and loss, damage to purchaser's documents, archives or data, damage for third party claims, and damage claimed by any party whatsoever, resulting from applications obtained by the purchaser for himself or third parties, with the help – or the use – of products purchased from Elcontrol.

### 1.10.4 Final provisions

The warranty conditions described herein supersede and void any other obligations and warranties which the parties may have agreed upon – both orally and in writing – before the purchase of NanoVIP® QUADRA™. Therefore, any such obligations or warranties shall be deemed void and invalid.

[blank intentionally]



## 2 POLAR ENERGY™ INSTALLATION

Polar Energy™ is installed to a panel via DIN 92x92 windows, according to IEC 61554 (ex DIN 43700) and blocked with the clamping band supplied.

Following picture shows the mechanical dimensions of the product and its corresponding drilling template.

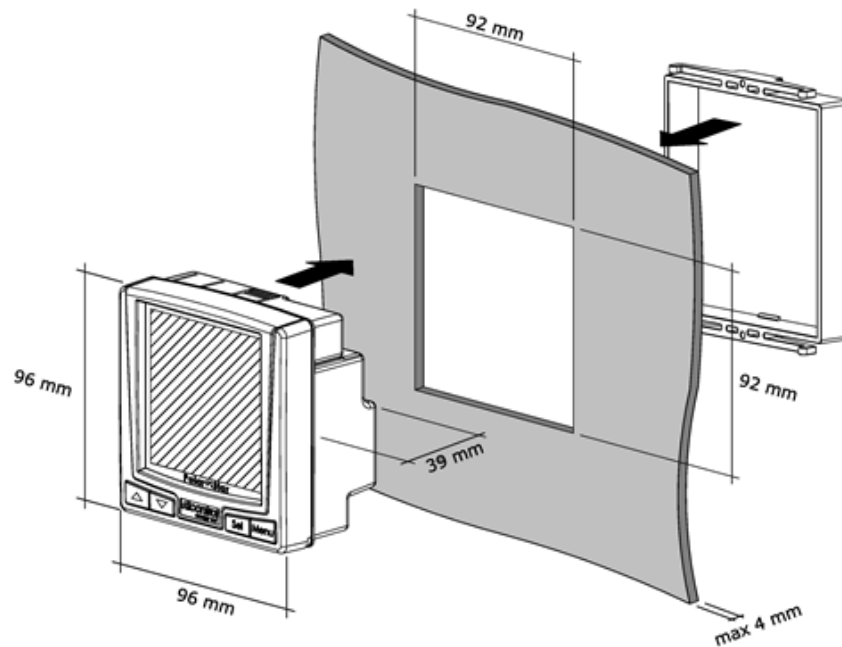

Moreover, it is possible to obtain the IP65 protection rating also for the drilling template by using the O-ring which can be ordered separately.

Polar Energy™ can be installed on plates and/or panels, the thickness of which should not exceed 4 mm (or 3 mm if the O-ring is inserted).

**NOTE: for connecting and starting up the optional modules, please refer to the relevant option manual**

## 2.1 OPTION MODULES

Polar Energy functions can be expanded through optional modules which can be inserted at the back of the instrument.

You can insert a maximum of two different options for each instrument.

Options should be inserted when the instrument is switched off. Pay attention not to damage the pins of the plug-in connector

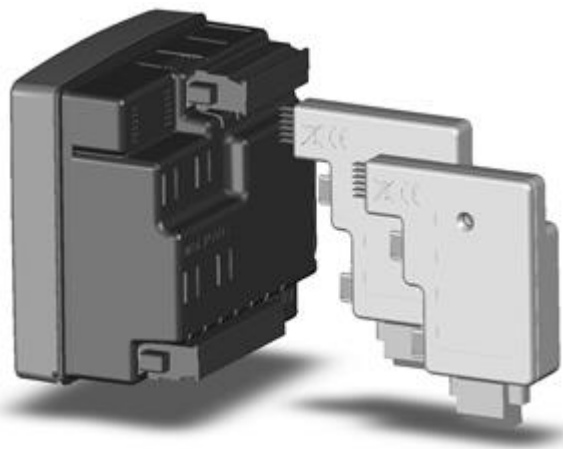

After inserting the option, turn on the instrument. All the pages relating to the set-up and display of the functions enabled will be automatically unlocked.

## 2.2 POWER SUPPLY AND ELECTRICAL CONNECTIONS

A label placed at the back of Polar Energy helps you identify the terminals and the different connections:

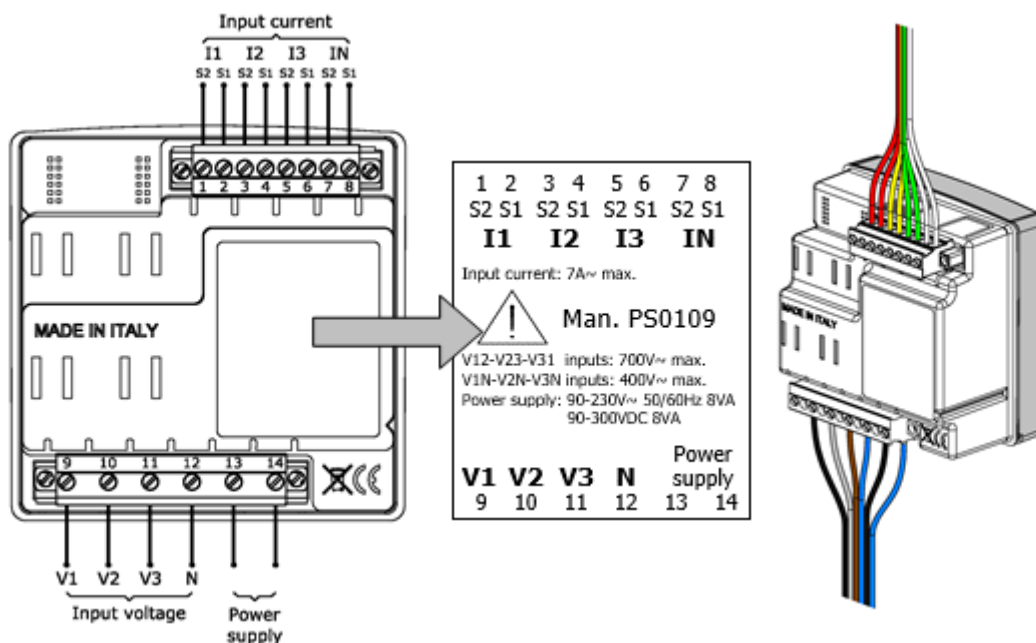

## 2.3 POWER SUPPLY

Polar Energy™ has 2 terminals for supply voltage which are marked Power supply.

Polar Energy can be powered from **90 to 230 V~**, with a +/-10% tolerance. Power supply frequency may be, without distinction, **50Hz or 60Hz**.

Alternatively, it may be powered through direct current from **90 to 300 VAC +/-10%**

Polar Energy is not equipped with internal fuse protection; one **200mA delayed fuse** should therefore be added on each power supply conductor.

By using the relevant option module, the device may be powered at **12-24VAC** or **48-60VAC**.

For installation and use of this device, please refer to the relevant option manual.

## 2.4 CONNECTION OF VOLTAGE AND AMPEROMETRIC INPUTS

Polar Energy has 3 voltage inputs called V1, V2 and V3, with common neutral (N).

Similarly, the instrument has 4 independent current inputs: I1 I2 I3 IN (neutral current, also known as 4th channel for auxiliary measurements).

**YOU MUST SHORT-CIRCUIT THE CTs BEFORE CONNECTING THEM TO THE INSTRUMENT!**



For the connection of the above-mentioned inputs to the network voltage, please refer to following paragraphs.

### 2.4.1 3PH+N: unbalanced three-phase network with neutral (4 leads / 3+1 CT)

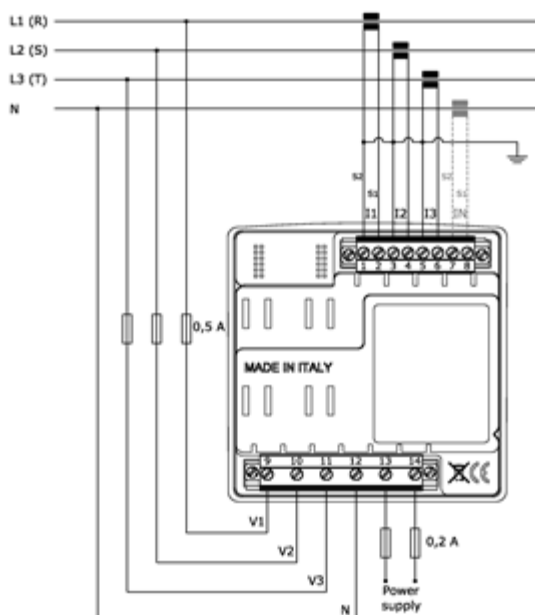

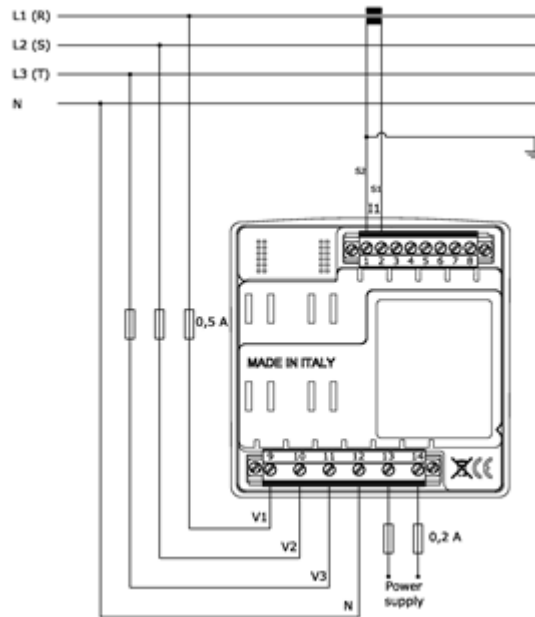
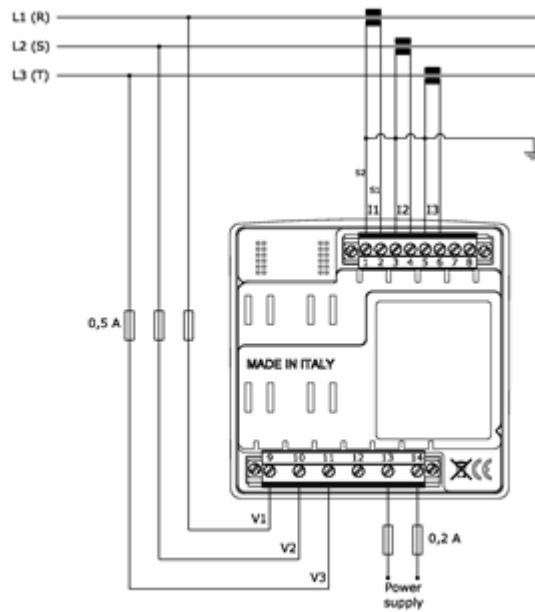
**2.4.2 3PH+N-BL: Balanced three-phase network with neutral (4 leads / 1 CT)****2.4.3 3PH: Unbalanced three-phase network without neutral (3 leads / 3 CTs)**

#### 2.4.4 3PH: Unbalanced three-phase network without neutral (3 leads / 2 CTs)

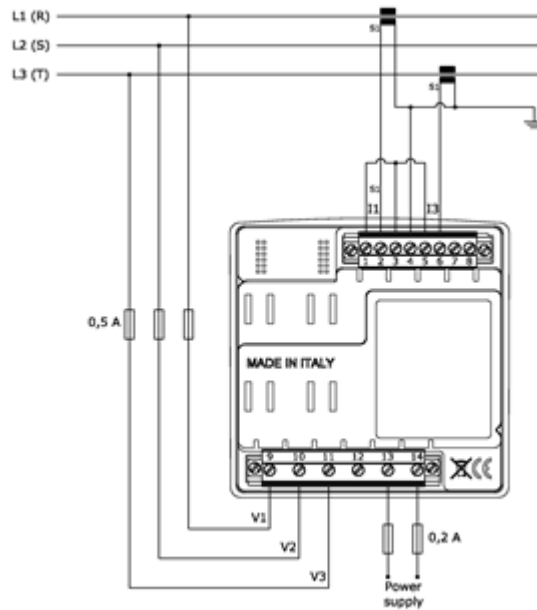

#### 2.4.5 3PH-BL: Balanced three-phase network without neutral (3 leads / 1 CT)

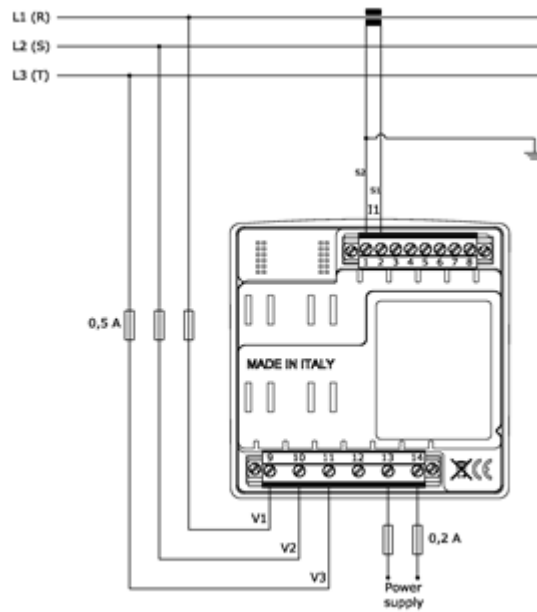

### 2.4.6 2PH: Two-phase network (3 leads / 2 CTs)

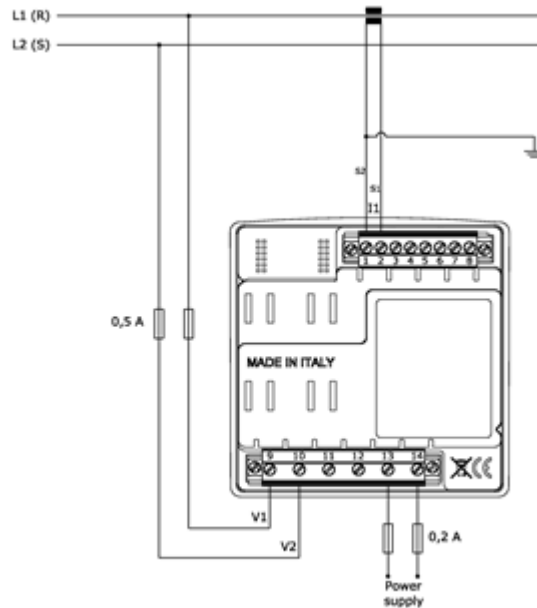

### 2.4.7 1PH: Single-phase network (2 leads / 1 CT)

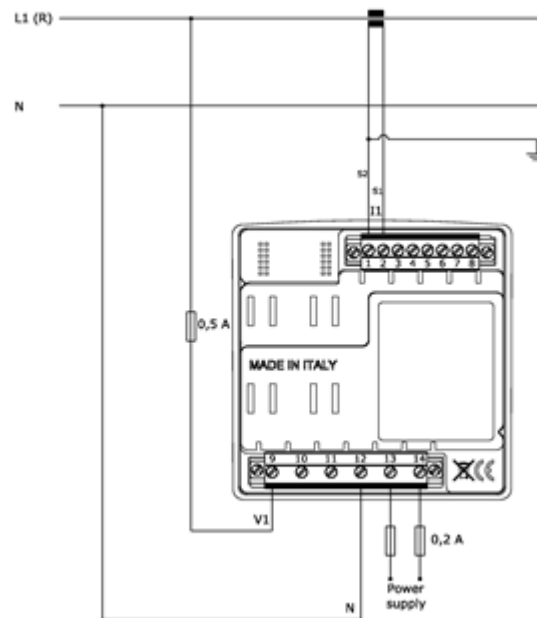

2.4.8 VT connection: Example of connection via Voltage Transformer

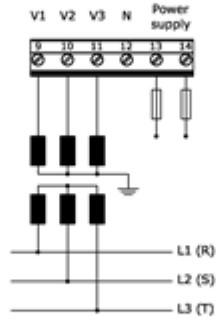





### 3 START-UP

Before using Polar Energy™ for the very first time, you need to configure it correctly according to the installation and plant to which it has been connected.

When the installation is completed, switch on the control board to turn the instrument on.

At the start-up, the instrument will display the following presentation page for a few seconds:

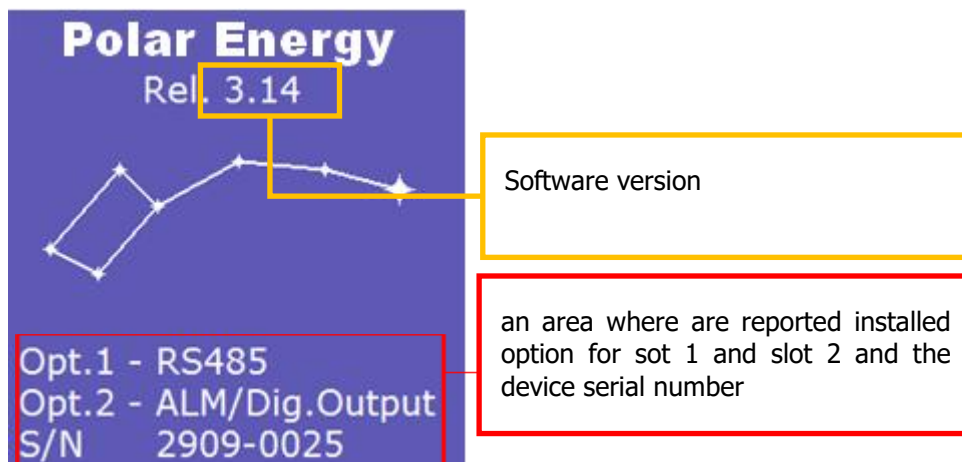

Afterwards, the instrument will show the voltage measurement menu.

#### 3.1 USER INTERFACE

Polar Energy is structured into MENUS. More specifically:

- Set-up menus
- Measurement menus.

##### 3.1.1 Setup and measurements pages

A typical SET-UP page consists of:

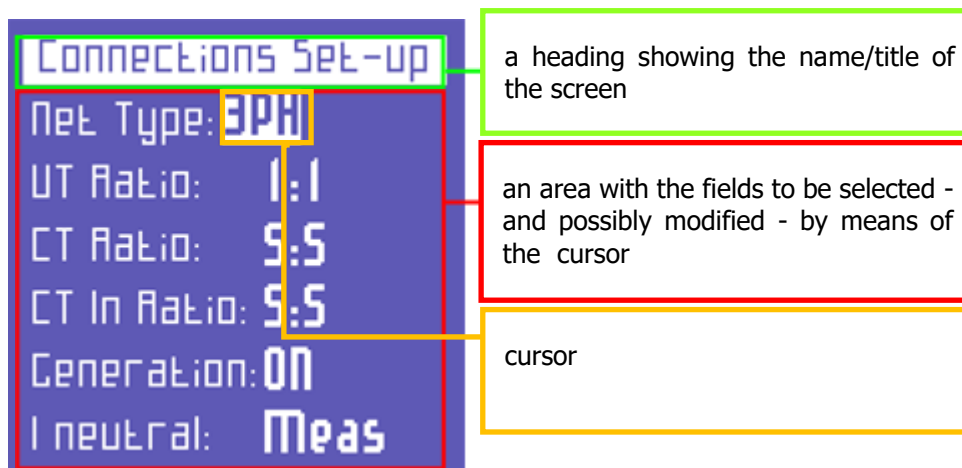

A typical MEASUREMENT screen consists of:

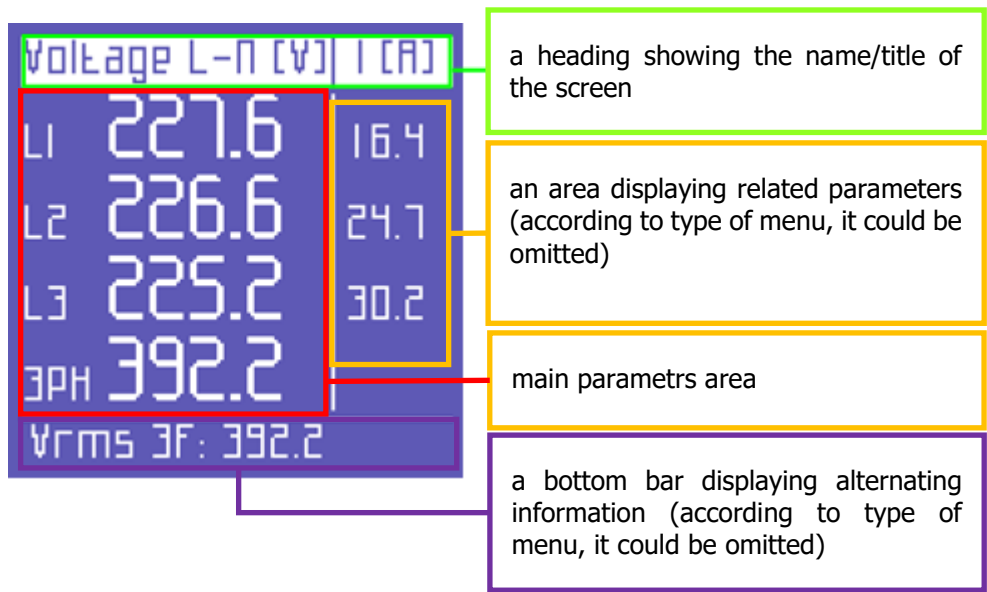

**NOTE: according to the type of menu, the secondary parameter area and/or the Bottom Bar might not be displayed.**









### 3.1.2 Keypad

Four keys allow users to navigate through the Menus and, where necessary, to edit the parameters.



The keypad is very easy to use - for further information, please refer to the set-up flowcharts and the measurement flowcharts. Its functioning may be summarised as follows:

KEY	FUNCTION
	Single pressure
	scrolling of measurement or set-up menus.
	<ul style="list-style-type: none"> <li>• selection of a parameter to edit in the set-up;</li> <li>• access to a measurement sub-page or sub-menu (e.g. for enabling the scrolling of the harmonic histogram or the alarms). In this case, when you press this key, the message ENTER will be displayed at the lower right corner of the screen</li> </ul>

	<ul style="list-style-type: none"> <li>• upwards scrolling of the pages of a measurement menu;</li> <li>• cursor up-movement in the set-up pages;</li> <li>• increase of a value selected in the set-up.</li> </ul>
	<ul style="list-style-type: none"> <li>• downwards scrolling of the pages of a measurement menu</li> <li>• cursor down-movement in the set-up pages;</li> <li>• decrease of a value selected in the set-up.</li> </ul>
 + 	<p>Enter or quirt the setup menu</p>
 + 	<p><u>only from the Voltage menu pages</u>, you can perform the electrical connection test to the plant</p>
 + 	<p><u>only from the connection set-up page</u>, hold these keys pressed for about 5 seconds in order to access the insert/change password for the set-up menus.</p>

### 3.2 PROGRAMMING AND SET-UP

#### 3.2.1 Editing and setting values

Press the keys simultaneously to access the instrument configuration menus.

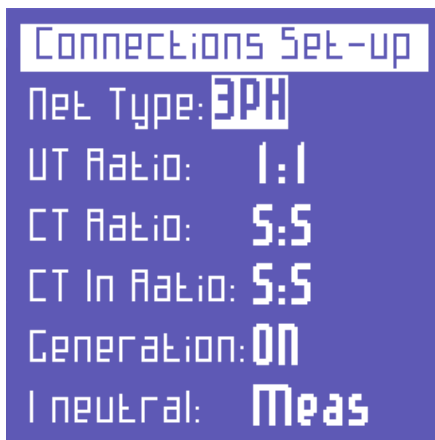

From here, press the keys and to move the cursor on the parameter to be configured.

By pressing the cursor will start blinking. Now press the keys and to edit the values highlighted by the cursor.

Press again to confirm the value. The cursor will stop blinking.

Press to scroll the set-up pages, as indicated in the flowchart below.

#### 3.2.2 Setup menu flowchart



NOTE: set-up pages relating to the options are automatically introduced in plug and play mode when optional devices are connected. For further information, please refer to the relevant option manuals.

To quit the SET-UP menu, press simultaneously the keys from any page.

### 3.2.3 Connection set-up

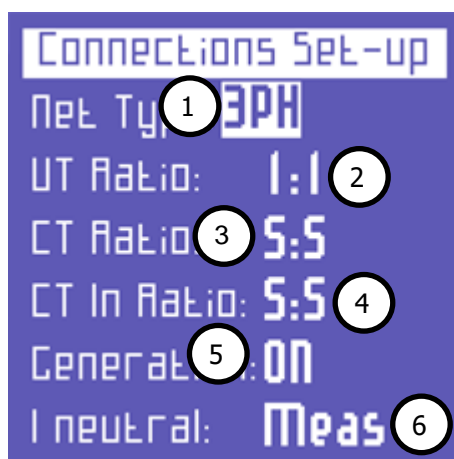

In this menu user can set:

- 1) the type of electrical network to which the instrument is connected.
- 2) the Voltage Transformation (VT) ratio.
- 3) the Current Transformation (CT) ratio for L1, L2 and L3.
- 4) the Current Transformation ratio for the I neutral
- 5) the activation or deactivation of measurement of generated powers and energies
- 6) actually measuring the I neutral or, in the absence of CT on In, calculating it from the other currents

#### 3.2.3.1 Electrical connection setup

In the **CONNECTIONS SET-UP** Menu, to set the type of connection, place the cursor on **NET TYPE** and choose one of the following options:

VOLTAGE TYPE	Description
3PH+N-BL	balanced three-phase system with neutral
3PH-BL	balanced three-phase system without neutral
3PH	unbalanced three-phase system without neutral
3PH+N	unbalanced three-phase system with neutral
2PH	two-phase system
1PH	single-phase system

#### 3.2.3.2 Voltage Ratio Set-up (VT)

When you need to connect a Voltage Transformer, or when you need to measure voltages higher than 600Vac, you need to set the relevant transformation ratio.

In order to do so, go to the **CONNECTIONS SET-UP** page, place the cursor on **VT** and edit the values (from 1 to 60000).

#### 3.2.3.3 Current Ratio Set-up (CT)

In order to set the current ratio of the CTs connected, go to the **CONNECTIONS SET-UP** page, place the cursor on **CT** and edit the values (from 1 to 60000).

### 3.2.3.4 Current Ratio Set-up of I Neutral

In order to set the current ratio of the CT on the 4th current channel, go to the CONNECTIONS SET-UP page, place the cursor on CT IN and edit the values (from 1 to 60000).

### 3.2.3.5 Cogeneration Set-up

You can set Polar Energy also when you need to measure the generated powers and energies, if any.

In order to do so, go to the **CONNECTIONS SET-UP** page, place the cursor on **GENERATION** and select **ON**.

By selecting **OFF**, the instrument will stop counting the energy generated, **which will always be considered as absorbed energy**.

*NOTE: by switching from Generation ON to Generation OFF, the generated energy counters will not be reset.*

### 3.2.3.6 Neutral Current Set-up

In unbalanced systems with neutral, you may decide whether to perform a real measurement of the In by using a dedicated CT or calculate it via Polar Energy according to the phase currents actually measured.

In order to measure the In, go to the CONNECTIONS SET-UP page, place the cursor on **I NEUTRAL** and select **MEAS**.

In order to make just one calculation of the In, deriving it from I1, I2 and I3, select **CALC**.

### 3.2.4 Counters Reset

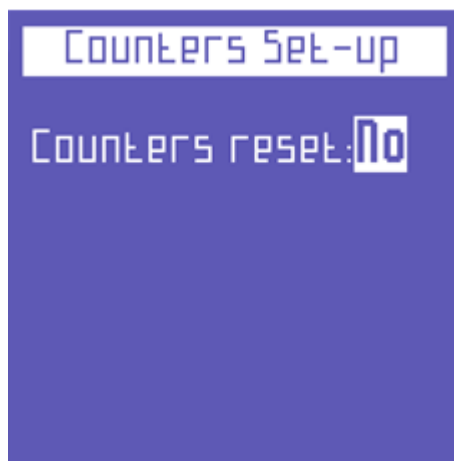

To reset absorbed and generated energy counters, go to the COUNTERS SET-UP page and select YES on COUNTERS RESET.

### 3.2.5 Language setup



Select one of the following languages:

- ENGLISH
- ITALIANO
- ESPAÑOL
- FRANÇAIS
- DEUTSCH

### 3.2.6 LCD Setup



The LCD SETUP page allows the user to set:

- 1) The backlight of the display
- 2) LCD contrast level
- 3) The display brightness
- 4) The menu type

### 3.2.6.1 Backlight Setup

The **LCD SETUP** page allows the user to set backlight of the display. Place the cursor on **BACKLIGHT** and select:

BACKLIGHT	Description
ALWAYS ON	
DELAY OFF 15 SEC	the backlight dims 15 seconds after the last key was pressed
DELAY OFF 1 MIN	the backlight dims 1 minute after the last key was pressed

Obviously, with time, LCD efficiency will depend on the number of hours of operation and the level of brightness selected. Therefore, unless strictly necessary, we advise against the level of brightness being higher than 70 and keeping the backlight ALWAYS ON.

*NOTE: the display turns on automatically if a video alarm goes on*

### 3.2.6.2 Contrast & Brightness Setup

To adjust the contrast and brightness of the display - so as to increase or decrease display efficiency and better adapt the instrument to different environmental conditions - place the cursor on **CONTRAST** or **BRIGHTNESS** and increase or decrease the parameters by increasing or decreasing the relevant values.

### 3.2.6.3 Menu Type Setup

Despite its easy-to-use interface, NanoVIP3 can perform a great number of measurements, and features many functions. If the user only needs a limited number of functions or measurements, this feature may sometimes be superfluous.

Therefore, to make using the instrument even easier, two different types of menus have been provided:

MENU TYPE	Description
TOTAL	All screens shown
PARTIAL	Menu, which only displays the Voltage, Currents, Power, Storage, and Setup Menus, making it less exhaustive but quicker to use

*The Partial Menu only affects the displayed information. All data are always stored. If the user subsequently selects the Full Menu, the analyses performed in the previously disabled menus will also be displayed.*

### 3.2.7 Alarm Setup and Reset

Two alarms can be set and configured with POLAR ENERGY™.



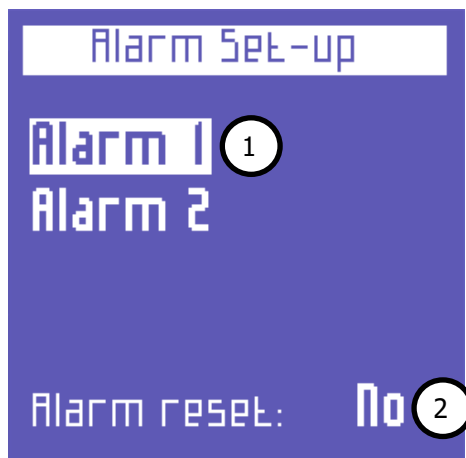

- 1) Place the cursor on either alarm and press  to access the relevant configuration submenu.
- 1) If you set **ALARM RESET** on **YES**, all the stored alarms which can be viewed in the **ALARM LOG** measurement menu are reset.

In the Alarm 1 or 2 configuration submenu, select OFF to disable the alarm or set the desired parameter to enable the alarm. The following parameters are available:

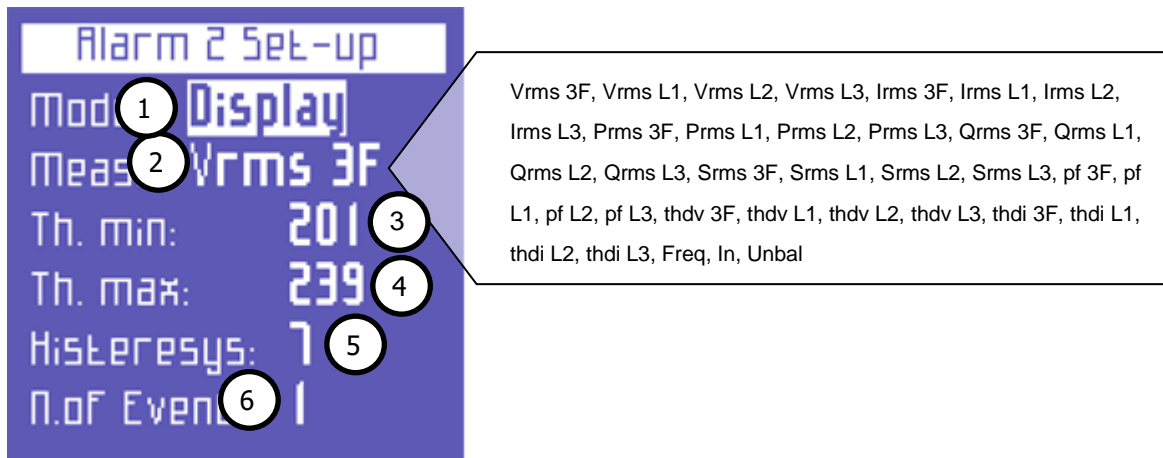

Alarm setting parameters meanings are as follows:

- 1) After entering the alarm 1 or 2 configuration sub-menu, you may disable it by setting **OFF** or activating it by setting **DISPLAY**
- 2) Available parameters as shown in picture
- 3) Set the minimum threshold value.
- 4) Set the maximum threshold value.
- 5) Set the hysteresis percentage (valid for both the minimum and maximum threshold).
- 6) Set the number of events after which the alarm should go off.

If one of the alarms set goes off, it will be indicated in the bottom bar of the measurement pages, where the alarm will be displayed permanently until it is cleared

	Voltage L-N [V]	I [A]
L1	218.2	0.02
L2	218.4	0.01
L3	218.4	0.01
3PH	378.2	
Alm. Vrms 3F=378.2		



**NOTE:** you can use the dedicated option to connect the alarm to a relay. For further information, please refer to the option manual ALM - DIGITAL OUTPUT.

Press  to go back to the **ALARM SET-UP** menu.

## 4 INSTRUMENT USE AND CONSULTATION

### 4.1 CONNECTION CHECK

When the instrument is connected, switched on and configured, you may check the connection to the electric system, if the PF is included in the one showed on the screen.

By pressing  and  simultaneously, the above-mentioned test will start and the relevant outcomes will be displayed.

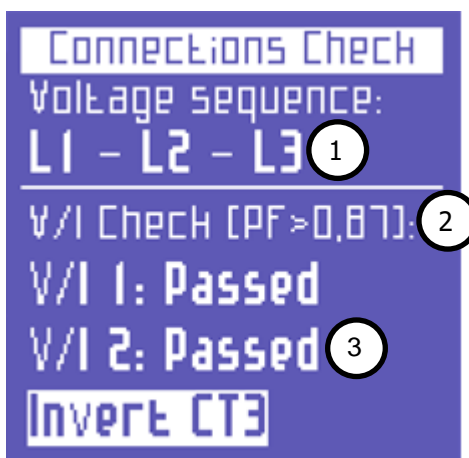

- 1) Voltage phase sequence
- 2) Threshold of the PF measured for a correct analysis
- 3) Check of the correspondence between voltage and current of each phase and possible error message.
  - a. PASSED = Connection is correct
  - b. INVERT CT= You need to invert the two input current leads
  - c. FAIL = Test failed because there is no correspondence between voltage and current, or because the PF is lower than the threshold displayed

To quit the connection test page, press .

### 4.2 MEASUREMENT MENU SCROLLING

Press the key  to scroll all the measurement menus. When you switch from one menu to another, the instrument always directs you to the first page of the selected menu.

Press the keys  and  to scroll the pages of each menu.

Some pages provide access to internal sub-functions by pressing .

Next paragraphs report measurement menu flowcharts

*NOTE: menus or single pages might not be displayed or edited, depending on the model (BASE or TOP), on the type of menu (COMPLETE or PARTIAL) and/or on the type of electrical connection (e.g. if you set the single-phase connection, the screens related to three-phase data will be deleted and the structure of many pages may change).*

### 4.3 THREE-PHASE OR TWO-PHASE CONNECTION MENU

At the start-up or when quitting the set-up menu, Polar Energy directs you to the first page of the voltage menu. As you can see from the flowcharts, menus have a circular structure: when you reach the last menu, if you keep scrolling, you are re-directed to the first menu.

Depending on the type of set connection, different situations may occur.

#### 4.3.1 Voltage Menu



Let us consider the following connections: 3PH+N (unbalanced three-phase with neutral), 3PH+N-BL (balanced three-phase with neutral) and 2PH (two-phase). If one of these connections is set, the first page will show the phase/neutral voltages, the corresponding phase currents and the three-phase voltage.

NOTE: if other electrical connections without neutral are set, this page will not be displayed.



▲ go to next page

▼ go to previous

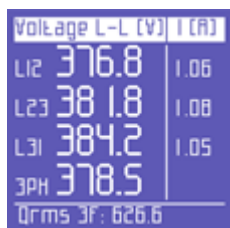

Line voltages and relevant phase currents.



▲ go to next page

▼ go to previous



Frequency (measured on L1).

NOTE: in a three-phase system, the unbalance value is a parameter indicating a condition in which the effective values of phase voltages or the phase angles between consecutive phases differ. This parameter is one of the values which serve as an indication of power quality. The lower the percentage value, the better the power quality.



▲ go to next page

▼ go to previous

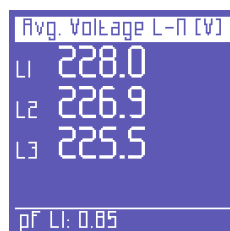

Average voltage levels (calculated on the basis of the integration time which has been set. Values can be reset..



▲ go to first page

▼ go to previous

### 4.3.2 Current menu

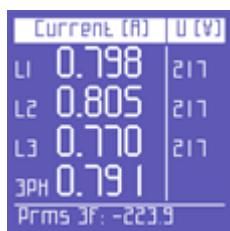

The first page of this menu shows the currents for each phase as well as the three- or two-phase current

By scrolling the pages of this menu, as indicated in section 5, the following pages will be displayed.



▲ go to next page

▼ go to previous



Neutral current (also known as 4th current channel).

NOTE: if the instrument is not set to 3PH+N or 3PH+N-BL mode (unbalanced or balanced three-phase with neutral), this quantity will always be 0.000.



▲ go to first page

▼ go to previous

### 4.3.3 Power Menu



The first page of this menu shows the active powers (W) of each phase and three- or two-phase connections, with the relevant PF values.

N.B. By convention, the generated active power is indicated as negative.



▲ go to next page

▼ go to previous



Reactive powers (Var) of each phase and three- or two-phase connections, with the relevant PF values.

N.B. By convention, the capacitive reactive power is indicated as negative. At 400Hz PF precision could be lower than in range 40Hz – 70Hz



▲ go to next page

▼ go to previous



Apparent powers (VA) of each phase and three-phase or two-phase connections, with the relevant PF values.

N.B. At 400Hz PF precision could be lower than in range 40Hz – 70Hz



▲ go to next page

▼ go to previous



The PF values for each phase and three- or two-phase connections, with the relevant type (Ind = inductive load; Cap = capacitive load)

NB. The PF parameter is always positive. By convention, it is indicated as negative when the active power is generated and not absorbed.



▲ go to first page

▼ go to previous

### 4.3.4 Counters Menu



The first page of this menu shows the counters of the active energy absorbed (+kWh) by each phase and three- or two-phase connections.

### 4.3.5 THD Menu

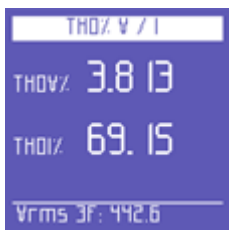

The first page of this menu shows the voltage THD% (Total Harmonics Distortion) on each phase and three- or two-phase connections as well as the relevant phase currents.

N.B. At 400Hz THD% could be affected by low precision due to reduced sampling rate

### 4.3.6 Waveform Menu

This menu shows the real-time waveforms and the relevant system voltage and current values.

*NOTE: currents can be distinguished from voltages since their waveform is identified by a small square marker. The waveform width is only indicative and is automatically adjusted to the screen size.*

*Quality of representation can decrease at 400Hz.*

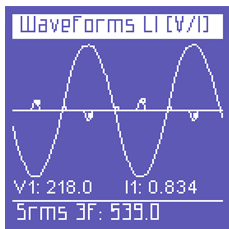

The first page shows the waveforms of L1 voltage and current



▲ go to next page

▼ go to previous

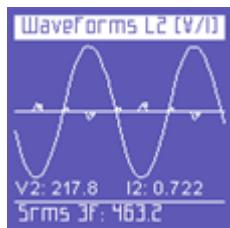

Waveforms of L2 voltage and current



▲ go to next page

▼ go to previous

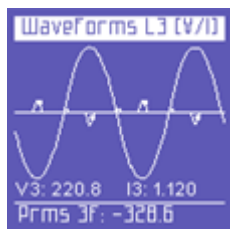

Waveforms of L3 voltage and current



▲ go to next page

▼ go to previous

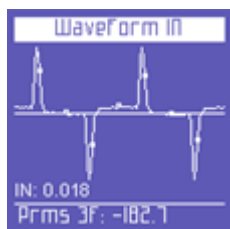

Waveforms of neutral current



▲ go to first page

▼ go to previous

## 4.4 SINGLE PHASE CONNECTION MENU

### 4.4.1 V I PF F Menu



The first page shows: voltage, current, PF and frequency.

By scrolling the other pages of this menu, as indicated in section 5, the following quantities are displayed



▲ go to next page

▼ go to previous



Average values for voltage, current and PF – calculation is made on the basis of the integration time. Values can be reset.



▲ go to first page

▼ go to previous

#### 4.4.2 P Q S PF Menu



Powers and PF

N.B. At 400Hz PF precision could be lower than in range 40Hz – 70Hz



▲ go to next page

▼ go to previous



Average values for powers and PF – calculation is made on the basis of the integration time. Values can be reset.



▲ go to next page

▼ go to previous



Minimum instant values for powers and PF. The values can be reset.



▲ go to next page

▼ go to previous



Maximum instant values for powers and PF. The values can be reset.





▲ go to first page

▼ go to previous

#### 4.4.3 Counters Menu



Counters of the energies absorbed (P+ Q+) and generated (P- Q-), as well as average value of the PF calculated as a kWh/kVAh ratio

N.B. At 400Hz PF precision could be lower than in range 40Hz – 70Hz

#### 4.4.4 THD Menu

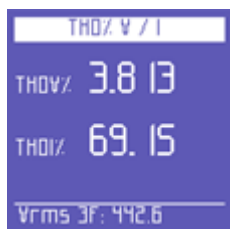

Voltage and current THD% value (Total Harmonics Distortion).

N.B. At 400Hz THD% could be affected by low precision due to reduced sampling rate

#### 4.4.5 Waveform Menu

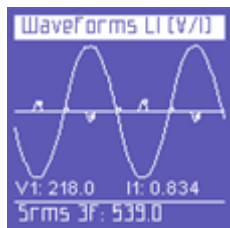

Waveform display of V and I.

*NOTE : current can be distinguished from voltage since its waveform is identified by a small square marker. The waveform width is only indicative and is automatically adjusted to the screen size*

## 5 MAINTENANCE

Polar Energy requires no special maintenance operations. It is sufficient to observe the standard rules that apply to any electronic equipment:

- clean the instrument with a soft and not frayed cloth;
- do not use detergents, corrosive or abrasive substances;
- do not store the instrument in wet places or at temperatures which are not allowed

### 5.1 ACCURACY CHECKING

The manufacturer cannot determine beforehand the accuracy checking intervals, since the instrument performances depend on the way the user operates the device (type of use, environmental conditions, etc.)

We therefore suggest a periodical check of the performances by means of a sample instrument, the class of which should be higher than that of Polar Energy, by fixing a yearly frequency and then increasing or decreasing the frequency of these checks on the basis of the results obtained.

If a new calibration is required, the instrument can be sent to the manufacturer's internal laboratory.

If necessary, the user can delegate the manufacturer to perform the accuracy checking.

**NOTE: there are no authorised calibration centres except for the internal calibration laboratory of Elcontrol Energy Net.**

## 5.2 REPAIR

Polar Energy is a sophisticated electronic product fully developed by Elcontrol Energy Net.

Any attempt to repair the instrument without the necessary skills may lead to safety risks.

We therefore recommend the user or non-authorised laboratories not to perform any repair, maintenance or calibration operations on this device. Any tampering with the device carried out by third parties will render the warranty null and void.

## 5.3 TROUBLESHOOTING

### 5.3.1 The instrument does not turn on.

Make sure the supply voltage falls within the instrument specifications.

Make sure the external fuses are intact.

### 5.3.2 The instrument does not measure correctly.

Make sure the amperometric and voltage ratios are suitable to the CTs and VTs connected to the plant.

Make sure the CTs are not wrongly connected.

Make sure the phase sequence is correct.

### 5.3.3 The display is unclear.

Check the brightness and contrast levels of the LCD.

### 5.3.4 After a few seconds, the display loses its brightness.

Check the screensaving setting

### 5.3.5 The display is always on, even if the setting chosen should prevent this from happening.

Check the presence of a video alarm

### 5.3.6 Some pages or menus are not displayed.

Make sure the menu setting is on Complete and not on Partial.

Make sure the connection type is correct.

### 5.3.7 The instrument lost date and time.

Polar Energy is not equipped with an internal battery. If the device is not used for a long time (more than 10 hours when it is completely charged), you need to set the clock again.

### 5.3.8 Countless alarms have been signalled.

Make sure the alarm level has a suitable hysteresis.

## 6 POLARLINK SOFTWARE

The software Polarlink is a practical remote simulator of Polar Energy and allows users to connect to an instrument and totally control the relevant user interface from a remote position.

In order to use it, copy the files from the CD supplied on a PC folder. Make sure the PC is connected to the communication interface (UBS/485 or RS232/485). Then, launch the SW, which will automatically try to connect to Polar Energy via all the PC serial ports.

Should the connection fail, right-click on an internal area of the SW screen to access the configuration menu.

Check/set the right connection address of Polar Energy and the relevant connection speed.

Perform another "Start".

When connection to Polar Energy has been established, you can operate on the SW interface with the mouse, as if you were in front of the instrument – in order to press two keys simultaneously, hold the key "Ctrl" pressed.

If "DEMO MODE" is set, the initial pages of each menu will be displayed in sequence.

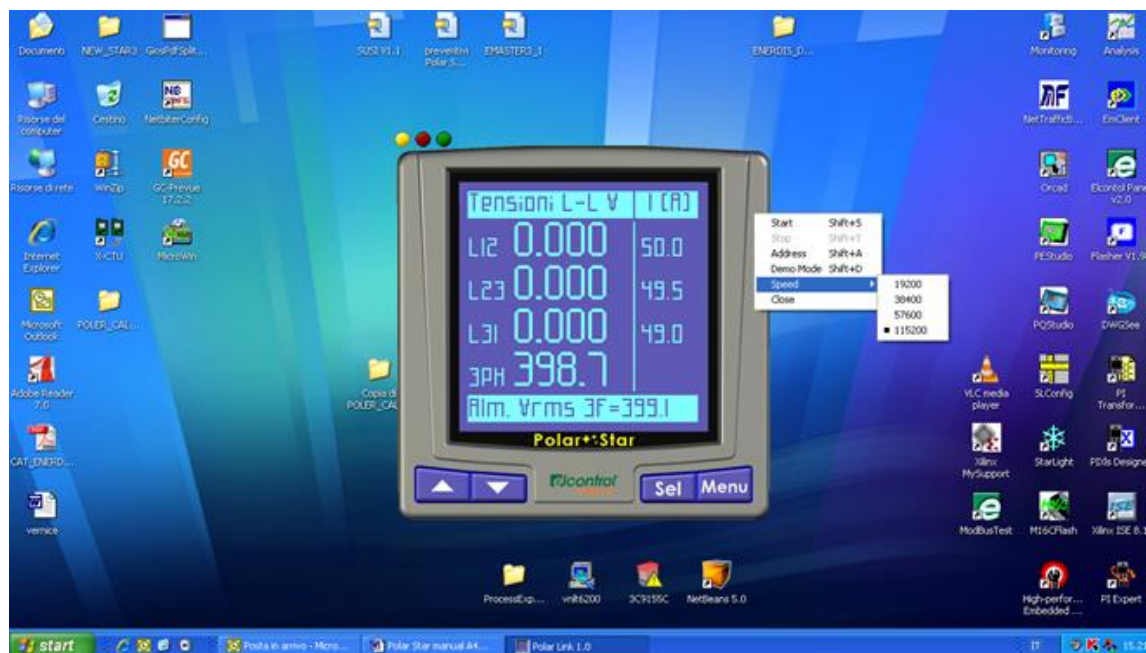



## 7 TECHNICAL SPECIFICATIONS

<b>ENCLOSURE:</b>	
Sizes	96x96x58 mm 96x96x96 mm (with option modules)
Overall dimensions inside the board	96x105x40 mm 96x105x77 mm (with option modules)
Material	ABS with V0 self-extinguish rating
Protection rating	IP65 (at the front), IP30 (at the back)
Weight	320 g + 35 g for each option
<b>DISPLAY:</b>	
Type	LCD dot matrix (graphic type) 128x128 FSTN negative
Backlight	White LED
Languages	English, Spanish, Italian, German, French
<b>KEYPAD:</b>	
Type	4 keys
Material	Silicone
<b>CONNECTIONS:</b>	
Supply and voltages	Removable terminals with retaining screws
Currents	Removable terminals with retaining screws
<b>POWER SUPPLY:</b>	
AC	90-230V ±10% 50 - 60 Hz 8VA
DC	90-300V ±10% 8W
DC (with dedicated option)	12-24V ±10%
DC (with dedicated option)	48-60V ±10%
Consumption	5VA
Wire section	2.5mm <sup>2</sup>
<b>MEASURES:</b>	
Refresh interval of video data	1 sec.
Type of possible connection	Three-phase (with 3 or 4 leads), two-phase (with 2 leads) and single-phase network
Type of network that can be connected	Low and Mean Voltage (LV)
VOLTAGE (TRMS)	
Available frequencies	From 40 Hz to 70 Hz and 400 Hz
Channels	3 channels with common neutral
Input impedance	4 Mohm

Direct measure	Phase-phase: 17-700VAC 40-70Hz, 400Hz Phase-neutral: 10-400VAC 40-70Hz, 400Hz
Measure through VT	Ratio: 1-60000 Max. value displayed: 20 MV
Permanent overload	800VAC
Sensitivity	10V Phase-neutral, 17 Phase-phase
Wire section	2.5mm <sup>2</sup>
<b>CURRENT (TRMS)</b>	
Channels	4 independent channels with shunt
Input consumption	<1VA
Scales	2
Direct measure	N/A
Maximum measurable current	8A
Measure through CT	Ratio: 1-60000 Max. value displayed: 500KA
Permanent overload	10A
Intermittent overload	50A 1 sec
Sensitivity	10mA
Wire section	2.5mm <sup>2</sup>
<b>POWERS</b>	
Single phase power	Values < 999 GW, Gvar, GVA
Total powers	Values < 999 GW, Gvar, GVA
<b>ENERGY COUNTERS</b>	
Max. value before reset	99999999 kWh, kvarh, kVAh
<b>ACCURACY</b>	
Voltages	±0.25% + 0.05%FS
Currents	±0.25% + 0.05%FS
Powers	±0.5% + 0.05%FS
Power Factor (PF)	±0.5° (from 40 Hz up to 50 Hz)
Frequency	±0.01 Hz (40 - 70Hz, 400 Hz)
Active energy count (kW)	Class 0.5
Reactive energy count (kVar)	Class 1
<b>CONDITIONS OF USE:</b>	
Operating temperature	from -10 to +55 °C

Storage temperature	from -20 to +85 °C
Relative humidity	Max 95%
Maximum operation altitude (a.s.l.)	2,000 m
<b>EC COMPLIANCE:</b>	
Directives	93/68/EEC (LV electrical equipment); 89/336/EEC and 2004/108/EC (EMC - Electromagnetic Compatibility) 2006/95/EC - 72/23/EEC (LVD - Low Voltage Directive); 2002/95/EC (RoHS - Restriction of Hazardous Substances); 2002/96/EC and 2003/108/EC (WEEE: Waste Electrical and Electronic Equipment)
<b>REFERENCE STANDARDS:</b>	
Safety	EN 61010-1
Electromagnetic Compatibility (EMC)	EN 61326 EN 61326/A1 EN 61326/A2 EN 61326/A3
Mechanical dimensions	IEC 61554 (ex DIN 43700)
Temperature	IEC 60068-2-1 (operating temperature) IEC 60068-2-2 (storage temperature)
Vibrations	IEC 60068-2-6
Humidity	IEC 60068-2-30 (humidity)
Overload	IEC 60947-1





## 8 OPTION MODULES

### 8.1 RS485 OPTION MODULES

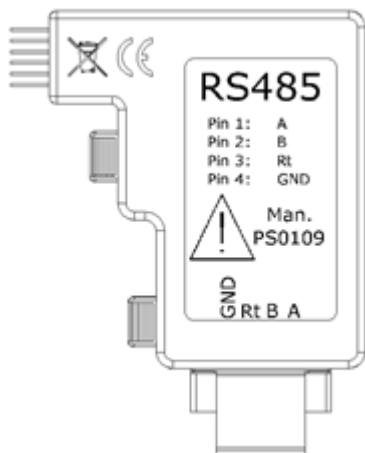

This option allows you to connect Polar Energy to an RS485 network to remotely transmit a long set of information via the MODBUS, BCD or IEEE protocols.

In order to guarantee the interchangeability between Polar Energy and the previous instruments produced by Elcontrol, the addresses of most standard MODBUS registers have not been modified. Furthermore, a new set of registers which start from the address 1000 has been especially dedicated to the new information that this instrument places at the user's disposal.

Moreover, in order to facilitate the correct network installation of the instrument, a special sub-menu has been created to indicate the traffic (for the instrument in question) and any possible communication errors.

#### 8.1.1 RS485 Option connections

A label placed on the side of the RS485 option of Polar Energy helps you identify the different connections.



- Pin 1: A
- Pin 2: B
- Pin 3: (make a shunt between pin 2 and 3 to connect the line termination 110 Ohm internal resistance)
- Pin 4: GND

#### 8.1.2 RS485 Option setup

The 485 set-up menu only displays when the relevant option is connected and allows you to set the following parameters:



- 1) data transfer speed (Baud rate) between the following: 4800, 9600, 19200, 38400, 57600, 115200 bps
- 2) parity type: none, even, odd

- 3) protocol type: BCD, IEEE (Mid Big-Endian), IEEEBE (Full Big\_Endian)
- 4) instrument address (which must be unique in the instrument network)
- 5) possibility to access the communication test page pushing 
- 6) possibility to access the date/time synchronization page of the network instruments pushing 

### 8.1.3 Communication test

This page is helpful during the instrument installation in an RS485 network or during a subsequent check of the instrument operation.

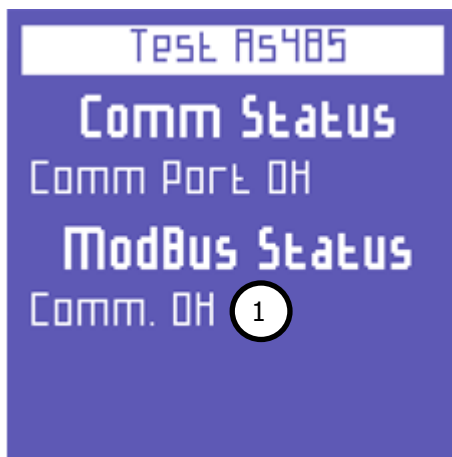

- 1) In this position, the working condition (No Traffic, Comm. OK) or the type of error (Checksum error, framing error etc.) which occur during the instrument communication are displayed.

*NB. If the error does not disappear, make sure the configuration parameters and the polarity of A and B signals connected to the RS485 option are correct.*

Press the key  to go back to the serial configuration menu.

### 8.1.4 Date/Time configuration

*Synchronization is only possible from address 1*

In the date/time synchronization set-up menu (which can only be accessed if the instrument address is the No. 1), it is possible to set the following parameters:



- 1) Enabling date/time synchronization
- 2) Entering the last network instrument address to synchronize
- 3) Deciding whether to perform the synchronization immediately or at the end of each day

*NB. Prevent repetitive synchronization from being performed every day if the instruments connected to the RS485 line can be interrogated by a management SW. In this case, message conflicts may arise on the line*

## 8.2 ALM OPTION

This option allows Polar Energy to have 2 optoisolated outputs, which are equivalent to 2 normally open free contacts. These outputs can be used in three different ways:

- **Pulse output:** Each output can be associated with an energy counter. The output contact will be closed, generating a number of pulses (10/100mS) which is proportionate to the counter increases (e.g. every 10Wh).
- **Alarm output:** Each output can be associated with a measure which can be selected from the set-up. The output contact will be closed each time the quantity value will exceed the set lower or upper limits.
- **Relay output:** This mode allows you to remotely control the two output contacts through the MODBUS "Force Single Coil" control (Coil No. 11 for out1 and No. 12 for out2)

### 8.2.1 ALM Option Connection

Technical characteristics:

- Nominal voltage: 24VDC
- Maximum current: 100mA

A label placed on the side of the RS485 option of Polar Energy helps you identify the different connections.

- Pin 1: Out 1
- Pin 2: Out 1
- Pin 3: Out 2
- Pin 4: Out 2

### 8.2.2 ALM Option Setup

In the Alarm/Pulse Set-up menu, which is only displayed when the relevant option is connected, it is possible to set the following parameters:

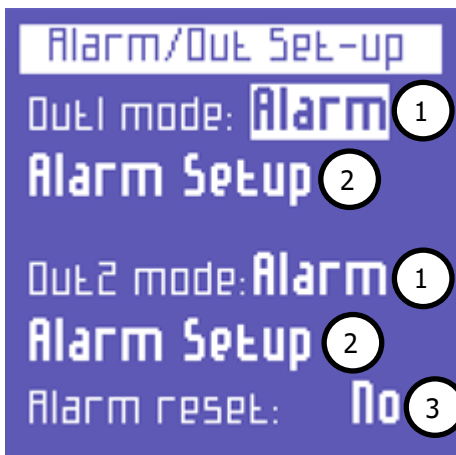

- 1) one of the three modes to use output 1 or 2:
  - a. ALARM: the contact output 1 or 2 is associated with an alarm condition which can be set from ALARM SET-UP
  - b. PULSE: the contact output 1 or 2 is associated with a measured energy value which can be set from PULSE SET-UP
  - c. RELAY: the contact is remotely controlled through a MODBUS control
- 2) allows you to access the alarm or pulse set-up page of the relevant output by pushing 
- 3) allows you to reset the alarms in the ALARM LOG menu

### 8.2.3 Alarm 1 or 2 Setup

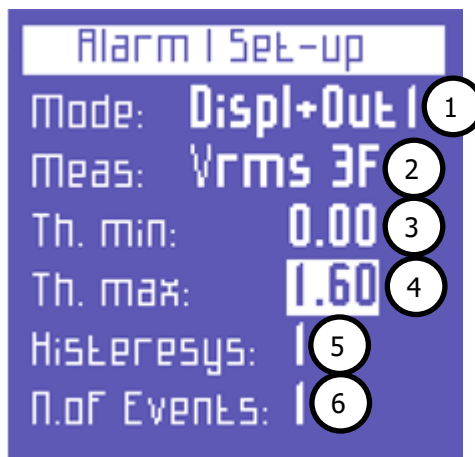

In the Alarm Set-up page it is possible to set the following parameters:

- 1) where to direct the alarm signal: on the display, on the corresponding output or both of them simultaneously
- 2) the measured quantity to be controlled
- 3) The minimum threshold

- 4) The maximum threshold
- 5) The hysteresis
- 6) the number of consecutive times the quantity must be out of limits (the two thresholds) in order for the alarm condition to occur

### 8.2.4 Pulse output 1 or 2 Setup

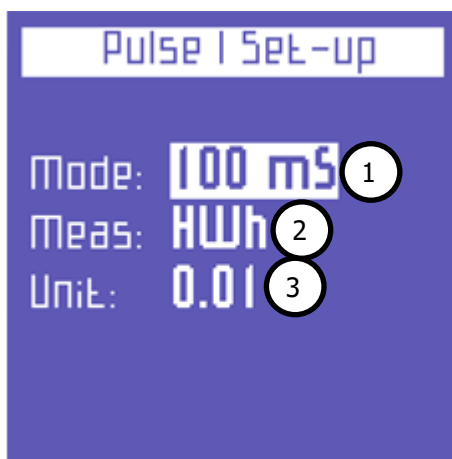

In the Pulse Set-up page it is possible to set the following parameters:

- 1) duration of the single pulse: 10 or 100 mS
- 2) measured energy counter that generates the pulse: kW, kVA, kVA
- 3) the value associated with each single pulse

### 8.3 DIGITAL INPUTS OPTION

This option allows Polar Energy to have 2 opto-insulated inputs, which can be connected to 2 clean external contacts. These inputs can be used in two different ways:

- **Auxiliary counters:** For counting the pulses coming from external counters and display them on the "Counters" menu.



- **Contacts for tariff identification:** For selecting the time period according to the closing of two normally open contacts which can be connected from the outside.

#### 8.3.1 Digital Inputs Option Connections

*Only connect clean contacts. 18VDC supply is provided by the instrument.*

A label placed on the side of the RS485 option of Polar Energy helps you identify the different connections.

- Pin 1: Input 2

- Pin 2: Input 2
- Pin 3: Input 1
- Pin 4: Input 1

When in "Counter" mode:

- Input 1 increases the AUX1 counter
- Input 2 increases the AUX2 counter

When in "Tariff Selection" mode:

<i>Selected Tariff</i>	<b>Input 1</b>	<b>Input 2</b>
T1	Open	Open
T2	Close	Open
T3	Open	Close
T4	Close	Close

### 8.3.2 Digital inputs Setup

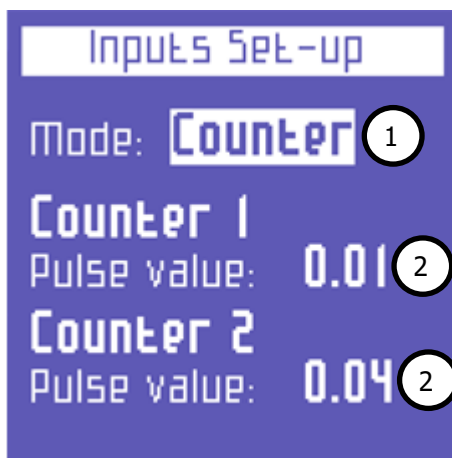

In the Digital Input Set-up menu, which is only displayed when the relevant option is connected, it is possible to set the following parameters:

- 1) the use of the two inputs: auxiliary counters or time period selectors
- 2) If the auxiliary counters use has been chosen, it is possible to set the value to be associated with each single pulse





Elcontrol Energy Net Srl  
Via Vizzano 44  
40037 – Sasso Marconi  
Bologna- Italy

**[www.elcontrol-energy.net](http://www.elcontrol-energy.net)**