

# Structure and Precision of Linear Guides

# Linear Guide Preload and Allowable Load

## Linear Guide - Structure and Features

### Miniature Type

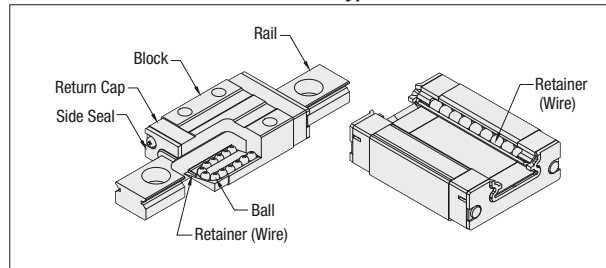

### Medium/Heavy Load Type

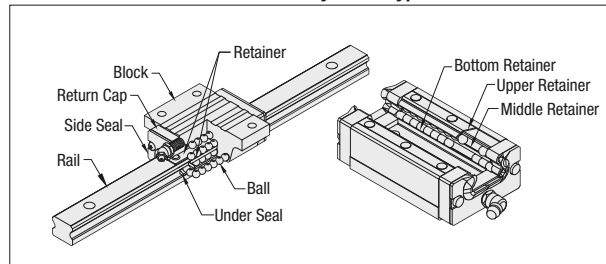

- Linear guides utilize steel balls rolling on precisely ground raceways, and the balls are recirculated by plastic return caps.
- End seals prevent foreign substances from intruding into the blocks.
- Miniature Type has two rows of contacting steel balls in a 4-point raceway contact design.
- Medium/Heavy Load Types have four rows of contacting steel balls in a 2-point raceway contact design.
- Load ratings are the same for all four directions (radial, reverse-radial, and lateral directions). Can be used in any orientation.
- Cautions

Do not apply a shock to the return cap. Doing so will affect the ball circulation and may cause sliding defects.

Balls do not fall out of MISUMI linear guides when removed from rails as the blocks are equipped with ball-retainers. However, the balls may fall out by rapidly removing blocks from the rail or inserting the rail into the block at a slant. Remove and install the blocks with caution.

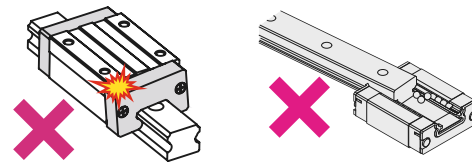

## Precision

### Dimensional Accuracy

Type	Accuracy Standards	Existing Products			C-VALUE Products	
		Precision Grade	High Grade	Standard Grade	Standard Grade	
Miniature Type	Height H Tolerance	±10	±20	±20	±40	
	Pair Variation of Height H	7	15	40	30	
	Width W <sub>2</sub> Tolerance	±15	±25	±25	±40	
	Pair Variation of Width W <sub>2</sub>	10	20	40	30	
Medium/Heavy Load Type	<b>Accuracy Standards</b>	<b>High Grade</b>	<b>Interchangeable</b>	<b>Standard Grade</b>	<b>Standard Grade</b>	
	Height H Tolerance	±40	±20	±100	±120	
	Pair Variation of Height H	15	15	20	40	
	Width W <sub>2</sub> Tolerance	±20	±30	±100	±100	
	Pair Variation of Width W <sub>2</sub>	24, 28	15	25	20	40
		33, 42	15	25	30	40
30, 36, 40, 42		-	25	-	40	

[Pair Variation of Height H]  
Difference between the min./max. values of Height (H) Dimension for a number of blocks combined on one rail.

[Pair Variation of Width W<sub>2</sub>]  
Difference between the min./max. values of Width (W) Dimension for a number of blocks combined on one rail.

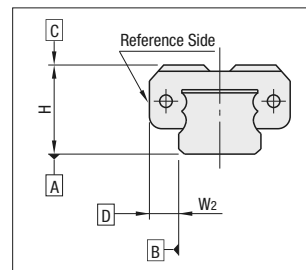

### Running Parallelism

Unit: μm

Rail Length (mm)	over	or Less	Miniature				Medium/Heavy Load			
			Existing Products	C-VALUE	Existing Products	C-VALUE	Existing Products	C-VALUE		
			Precision Grade	High Grade	Standard Grade	Standard Grade	High Grade	Interchangeable	Standard Grade	Standard Grade
50	50	80	2	3	13	13	7	6	7	10
50	80	125	2	3	13	13	7	6.5	7	10
80	125	200	3	7	15	15	7	7	7	10
125	200	250	3.5	9	17	17	7	8	7	10
250	315	315	4	11	18	18	8	9	12	10
315	400	400	5	11	18	18	8	11	12	12
400	500	500	5	12	19	19	9	12	14	13
500	630	630	6	13.5	21	21	11	14	18	15
630	800	800	6	14	21.5	21.5	13	16	21	17
800	1000	1000	-	-	-	-	14.5	18	23	19
1000	1250	1250	-	-	-	-	16	20	25	22
1250	1600	1600	-	-	-	-	-	23	27	23
1600	2000	2000	-	-	-	-	-	26	28.5	24

### [Running Parallelism]

Measured while the rail is bolted firmly to a standard datum surface base. A relative variation of block's top surface C against the rail's bottom surface A, and a relative variation of block's datum surface D against the rail's datum surface B are measured, as the block is run from end to end on the rail.

- Running Parallelism of Plane C against Plane A

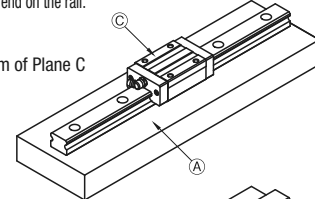

- Running Parallelism of Plane D against Plane B

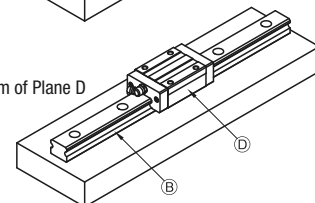

## Selection of Radial Clearance (Preload)

Type	Preload	Size (Height H Dimension)	Radial Clearance (μm)	
Miniature	Existing Products	Light Preload	-3~0	
	C-VALUE Products	Slight Clearance	0~+15	
		Normal Clearance	-3~+7	
Medium/Heavy Load	Existing Products	Normal Clearance	24	
			28	
			33	
			24, 28	
			30, 36, 40, 42	
	C-VALUE Products	Interchangeable, Light Preload	*42	-5~0
		Normal Clearance		24
				28, 30
				33, 36, 40
				45

\* marked size is for Super Heavy / Extra Super Heavy Load.

- Clearance and preload of MISUMI Linear Guides are controlled with minute ball size adjustments.
- Increased rigidity and reduced elastic deformation will result by preloading (negative clearance).
- Generally, selecting some preloads would cause favorable effects on accuracy and life of Linear Guides.
- MISUMI-manufactured Blocks and rails guarantee their own radial clearances (preload) and accuracies as sets of blocks and rails. Be sure to use the blocks and rails in sets.

## Friction Force (Required Thrust Force)

Linear Guide friction force (required thrust) varies depending on load, speed and lubricant property. Especially when moment load is applied, Preload Type friction force increases. Although seal resistance varies according to seal lip press-fit allowance and lubrication conditions, it is not proportionate to load and keeps a constant value. Friction force is obtained by the following formula.

$$F = \mu \cdot W + f$$

- F : Friction (N)
- μ : Dynamic Friction Coefficient
- W : Applied Load
- f : Seal Resistance (2N ~ 5N)

Table-1. Dynamic Friction Coefficient

Type	Dynamic Friction Coefficient (μ)
Miniature Linear Guides	0.004~0.006
Linear Guides for Medium Load	0.002~0.003

## Allowable Load

- Basic Dynamic Load Rating (C)  
Basic dynamic load rating is defined as: a load applied in a constant direction and ran under equal condition on a group of linear guide specimen where 90% of specimen will reach 50x10<sup>6</sup>m without experiencing any damages due to rolling fatigues.
- Basic Static Load Rating (Co)  
Basic static load rating is defined as: a load applied on non-moving linear guides where a sum of rolling element plastic deformation amount and rolling surface plastic deformation amount becomes equal to 0.0001 times that of the diameter of the rolling element (balls).
- Allowable Static Moment (MA, MB, MC)  
Allowable static moment is a critical static moment load defined by permanent deformation value similar to basic static load rating Co.

$$\text{Allowable Load (N)} \leq Co/fs$$

$$\text{Allowable Moment (N} \cdot \text{m)} \leq (MA, MB, MC)/fs$$

fs: Static Safety Factor Co: Basic Static Load Rating (N)  
MA, MB, MC: Allowable Static Moment (N · m)

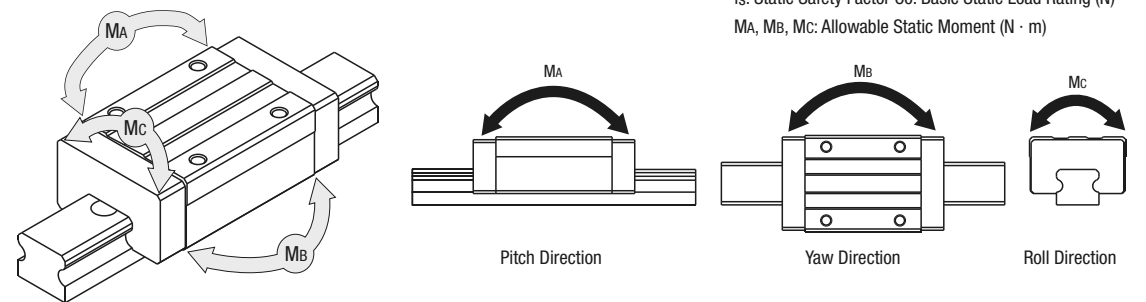

- Static Safety Factor (fs)  
Basic Static Load Rating Co, in the static state or in low speed, is divided by Static Safety Factor fs in Table - 2 depending on operating conditions.

Table-2. Static Safety Factor (fs Lower Limit)

Condition of Use	Lower Limits of fs
For normal operating condition	1~2
When smooth running performance is required	2~4
When vibrations and impacts exist	3~5